



9 Up / Down button ▲ ▼ (in display mode, normal state)

Press shortly	Change to the menu mode, display of alarm memory (Down) / cumulative time of alarms, standby counter, standby time (Up), pushing of Set button for ≥ 2 s makes a reset of the stored values
Press for > 2 s	Display of MAX (Up) / MIN (Down) measured values, additional pushing of Set button for ≥ 2 s deletes the stored values

10 LEDs Allocation of the measured value (yellow)

LEDs	Measured value
Lx and N ON	Voltage (L1 against N, L2 against N, L3 against N)
Lx and Ly ON	Voltage (L1 against L2, L2 against L3, L1 against L3)
Lx flashing quickly	Vector shift (L1, L2, L3)
L1 flashing	Frequency

11 Sealable button + LED

Press for > 2 s	Lock / Unlock
 LED red	Settings and simulation mode are locked, in case of setting attempts Loc is displayed for 3 s
 LED green	Setting and simulation enabled

2 Description of the connections

A1 and A2	Rated control supply voltage U_s , see Technical Data (any polarity)
11, 12, 14; 21, 22, 24	Relay K1 and K2
E1 – E2 Enable – Input	Volt-free contact
	$u5r \rightarrow oFF$, no function
	$u5r \rightarrow on$, E1-E2 closed: vector shift active but not evaluated, monitoring of feedback contacts Y1/Y2 off for use with generator
	$u5r \rightarrow StBY$, E1-E2 closed: K1 and K2 off (standby), vector shift off
Y0, Y1, Y2 Inputs, feedback contacts	Volt-free n/o or n/c contact, self-learning when switching on
	Adjust the turn-on time of the section switch under $rEL \rightarrow t_rEL$, switch-off (oFF) if not connected or if switches are controlled from other device
I1	Supply voltage for digital outputs, max. 27 V DC
Q1...Q4	Digital output over-/undervoltage/-frequency, Q3 + Q4 = ROCOF
Q5	Digital output Error, in Program 3-6 additionally the 2nd threshold value
L1, L2, L3, N	Phase L1, L2, L3 and neutral conductor

3 Important notice



In the supply line in the vicinity of the device (easily accessible), a switch marked as disconnecting device as well as an overcurrent protection element (rated current ≤ 6 A) have to be provided.



Attention!
For the rated control supply voltage, see label at the side of the unit!



WARNING

Hazardous electrical voltage!
Can lead to electric shock and burns.
Before starting work, switch plant and device voltage-free.

4 Mounting

The device can be mounted:

- Distribution panel or control panel on 35 mm rail according to EN 60715

Comply with the maximum permissible temperature when installing in a switch cabinet. Ensure sufficient clearance to other devices or heat sources. If cooling is inhibited, e.g., through close proximity to devices with increased surface temperature or interference with the cooling-air current, the permissible ambient temperature is decreased.



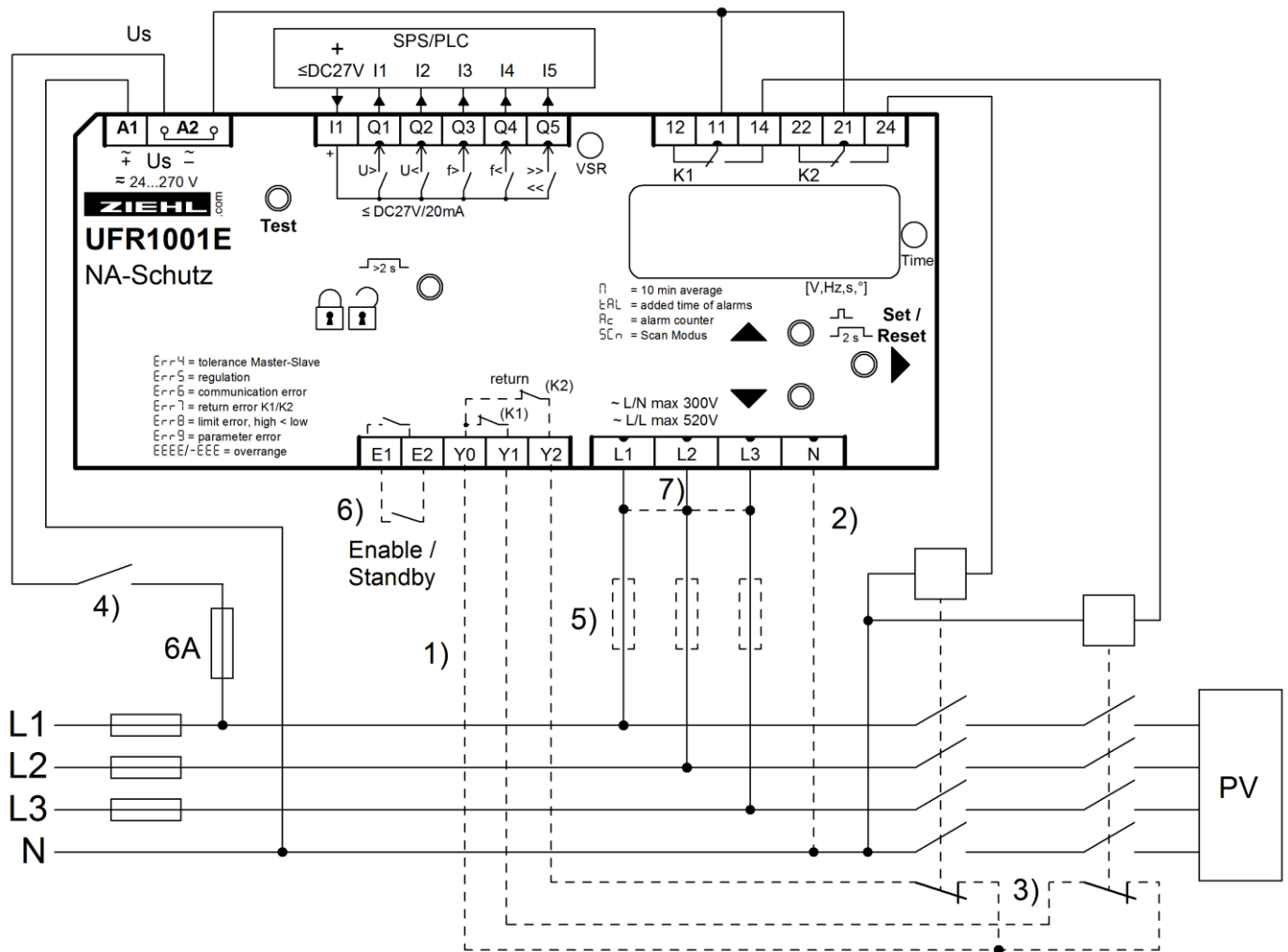

5 Connection diagram



- 1) Feedback contacts not connected: set **rEL** → **tEL** → **off**.
- 2) N connected: select **Pr 1**, **Pr 3** or **Pr 5**
- 3) Nc- or no-contacts can be connected, self-learning when switching on
- 4) Switch off of plant without recording an alarm, e.g. with contact of a ripple control receiver
- 5) Fuses only when line protection necessary, e.g. 3x16A
- 6) Contact closed suppresses evaluation of feedback contacts and vector shift (**uSr** → **on**), suppresses evaluation of feedback contacts (**uSr** → **yIy2**) or switches to standby (**uSr** → **StBY** = default) e.g. by ripple control receiver or clock
- 7) 1 phase Application connect L1-L2-L3, 2 phase Application L1 / L2+L3 (only Pr 5, 7, 10, 20)

6 Program setup

The suitable program must be set on the UFR1001E in accordance with the application. If the UFR1001E is sealed/locked (red LED  lightning), sealing has to be deactivated first.

Pr	Connection	Threshold Values	Voltage	Country / Standard
*1	3 AC with N	<u>Low voltage</u> 1x overvoltage, 1x undervoltage 1x overfrequency, 1x underfrequency 10 min average value, 1x vector shift 1x ROCOF	230V	 VDE-AR-N 4105
2	3 AC without N		400V	
7	2/1 AC with N		230V	
3	3 AC with N	<u>Medium voltage</u> 2x overvoltage, 2x undervoltage 2x overfrequency, 2x underfrequency 10min mean value, 1x vector shift 1x ROCOF	57,7V	 BDEW Juni 2008 nach 3.2.3.3-1
4	3 AC without N		100V	
5	3/2/1 AC with N		230V	
6	3 AC without N		400V	
10	3/2/1 AC with N	1x overvoltage, 1x undervoltage 1x overfrequency, 1x underfrequency 10 min average value, 1x vector shift 1x ROCOF	230V	 ÖVE/ÖNORM E 8001-4-712
20	3/2/1 AC with N	2x overvoltage, 2x undervoltage 2x overfrequency, 2x underfrequency 10min mean value, 1x vector shift 1x ROCOF	230V	 G83/2 + G59/3
21	3 AC without N		400V	
22	3 AC with N		57,7V	
23	3 AC without N		100V	

* default setting

Adjustment process:

- If present, remove seal (only authorised person)
- Apply control supply voltage at A1-A2
- Slightly lift the button cover and turn 180°
- Actuate the small blue button by strong pressing on the button cover (LED starts flashing) until the green LED  is lightning.
- Press button ▲ 1x → Display | nFα.
- Press button ▶ 5x → Display Pr l.
- Set the program with the buttons ▲ ▼
- Press button ▶ 1x → Display nα.
- Press button ▼ 1x → Display 4E5.
- Press button ▶

⇒ Device resets and starts with the newly selected program

Hint: When changing programs, all parameters of the selected program are reset to “default settings” (see table „Default settings“). Only change the parameters after having selected the correct program.





7 Technical data

<u>Rated control supply voltage</u> U_s :	24-240V AC/DC -15...+10 %, DC / 40-70 Hz, <5 VA
<u>Output relays:</u>	2 c/o contacts
Max. switching voltage	400 V AC
Inrush current (at 10 % ED)	25 A max. 4 s / 50 A max. 1 s
Rated operational current I_e (AC15)	230 V AC / 6 A
Fuse rating to achieve short-circuit protection	max. gG/gL 6 A
<u>Output voltage - transistor outputs</u>	Q1-Q5
Operational voltage V_Q	4.5-27 V DC
Max. current consumption Q1...Q5	20 mA / output
<u>Input circuit - feedback contacts</u>	Y0 – Y1/2
No-load voltage at the control inputs	15-35 V DC
	Feedback time section switch 0.5-99.0 s selectable

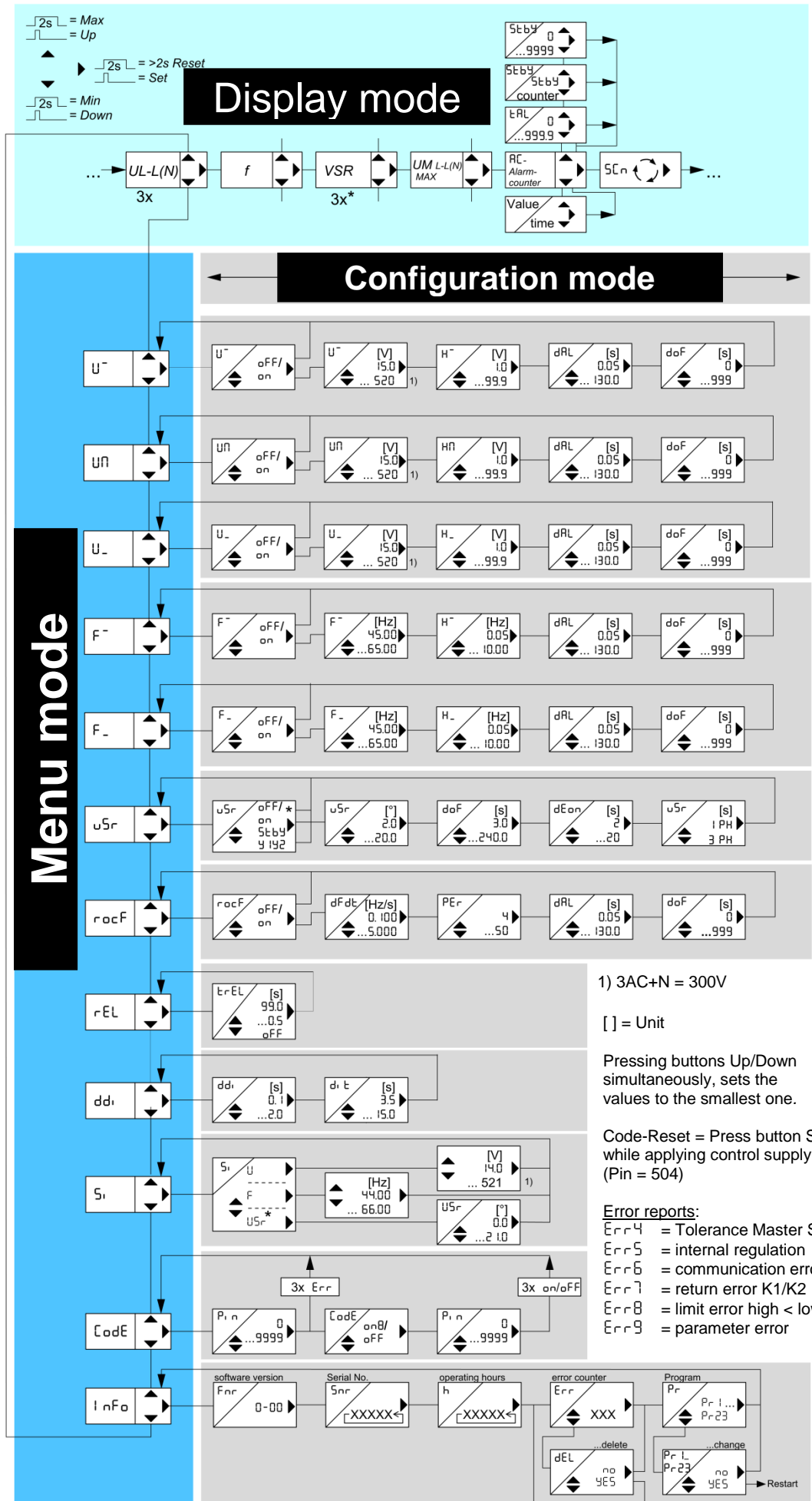
Subject to change without prior notice

8 Control chart, Pr1, 2, 7, 10 (3-6, 20-23 Detailed operating manual see www.ziehl.de/ziehl/ba)



Pr	Connection	Country / Standard
*1	3 AC + N	 VDE-AR-N 4105
2	3 AC	
7	2 / 1 AC + N	
3	3 AC + N	 BDEW Juni 2008 nach 3.2.3.3-1
4	3 AC	
5	3 / 2 / 1 AC + N	
6	3 AC	 ÖVE/ ÖNORM E 8001-4- 712
10	3 / 2 / 1 AC + N	
20	3 / 2 / 1 AC + N	
21	3 AC	 G83/2 + G59/3
22	3 AC + N	
23	3 AC	

1) 3AC+N = 300V

[] = Unit

Pressing buttons Up/Down simultaneously, sets the values to the smallest one.

Code-Reset = Press button Set 2 s while applying control supply voltage. (Pin = 504)

- Error reports:**
- Errr4 = Tolerance Master Slave
 - Errr5 = internal regulation
 - Errr6 = communication error
 - Errr7 = return error K1/K2
 - Errr8 = limit error high < low
 - Errr9 = parameter error

9 Default settings and firmware version

When changing programs, all parameters are reset to the default settings.

Menu	Parameter / Unit		Default settings 							Users Data
			Low voltage VDE-AR-N 4105			Medium voltage BDEW				
			3 AC+N 230V	3 AC 400V	2/1 AC+N 230V	3 AC+N 57,7V	3 AC 100V	3/2/1AC +N 230V	3 AC 400V	
			Pr1 *	Pr2	Pr7	Pr3	Pr4	Pr5	Pr6	
U ⁺⁺	U ⁺⁺ Alarm on/off		-	-	-	on	on	on	on	
	U ⁺⁺ Overvoltage	V	-	-	-	66.4	115	264	458	
	H ⁺⁺ Hysteresis	V	-	-	-	1.0	1.0	3.0	3.0	
	dRL Response time	s	-	-	-	0.10	0.10	0.10	0.10	
	doF OFF-delay	s	-	-	-	60	60	60	60	
U ⁻	U ⁻ Alarm on/off		on	on	on	on	on	on	on	
	U ⁻ Overvoltage	V	264	458	264	62.3	108	249	430	
	H ⁻ Hysteresis	V	5.0	5.0	5.0	1.0	1.0	3.0	3.0	
	dRL Response time	s	0.10	0.10	0.10	60.00	60.00	60.00	60.00	
	doF OFF-delay	s	60	60	60	60	60	60	60	
UN	UN Alarm on/off		on	on	on	oFF	oFF	oFF	oFF	
	UN Overvoltage	V	253	438	253	63.5	110	253	438	
	HN Hysteresis	V	3.0	3.0	3.0	1.0	1.0	3.0	3.0	
	dRL Response time	s	0.10	0.10	0.10	0.10	0.10	0.10	0.10	
	doF OFF-delay	s	60	60	60	60	60	60	60	
U ₋	U ₋ Alarm on/off		on	on	on	on	on	on	on	
	U ₋ Undervoltage	V	184	318	184	46.2	80.0	184	318	
	H ₋ Hysteresis	V	5.0	5.0	5.0	1.0	1.0	3.0	3.0	
	dRL Response time	s	0.10	0.10	0.10	2.70	2.70	2.70	2.70	
	doF OFF-delay	s	60	60	60	60	60	60	60	
U ₊₊	U ₊₊ Alarm on/off		-	-	-	oFF	oFF	oFF	oFF	
	U ₊₊ Undervoltage	V	-	-	-	26.0	45.0	104	180	
	H ₊₊ Hysteresis	V	-	-	-	1.0	1.0	2.0	2.0	
	dRL Response time	s	-	-	-	0.30	0.30	0.30	0.30	
	doF OFF-delay	s	-	-	-	60	60	60	60	
F ⁺⁺	F ⁺⁺ Alarm on/off		-	-	-	oFF	oFF	oFF	oFF	
	F ⁺⁺ Overfrequency	Hz	-	-	-	51.50	51.50	51.50	51.50	
	H ⁺⁺ Hysteresis	Hz	-	-	-	1.45	1.45	1.45	1.45	
	dRL Response time	s	-	-	-	0.10	0.10	0.10	0.10	
	doF OFF-delay	s	-	-	-	60	60	60	60	
F ⁻	F ⁻ Alarm on/off		on	on	on	on	on	on	on	
	F ⁻ Overfrequency	Hz	51.50	51.50	51.50	51.50	51.50	51.50	51.50	
	H ⁻ Hysteresis	Hz	1.45	1.45	1.45	1.45	1.45	1.45	1.45	
	dRL Response time	s	0.10	0.10	0.10	0.10	0.10	0.10	0.10	
	doF OFF-delay	s	60	60	60	60	60	60	60	

Menu	Parameter / Unit		Default settings 							Users Data	
			Low voltage VDE-AR-N 4105			Medium voltage BDEW					
			3 AC+N 230V	3 AC 400V	2/1AC+N 230V	3AC+N 57,7V	3 AC 100V	3/2/1AC +N 230V	3 AC 400V		
			Pr 1 *	Pr 2	Pr 7	Pr 3	Pr 4	Pr 5	Pr 6		
F_	F_	Alarm on/off		on	on	on	on	on	on	on	
	F_	Underfrequency	Hz	47.50	47.50	47.50	47.50	47.50	47.50	47.50	
	H_	Hysteresis	Hz	1.00	1.00	1.00	1.00	1.00	1.00	1.00	
	dRL	Response time	s	0.10	0.10	0.10	0.10	0.10	0.10	0.10	
	doF	OFF-delay	s	60	60	60	60	60	60	60	
F_	F_	Alarm on/off		-	-	-	oFF	oFF	oFF	oFF	
	F_	Underfrequency	Hz	-	-	-	47.50	47.50	47.50	47.50	
	H_	Hysteresis	Hz	-	-	-	1.00	1.00	1.00	1.00	
	dRL	Response time	s	-	-	-	0.10	0.10	0.10	0.10	
	doF	OFF-delay	s	-	-	-	60	60	60	60	
u5r	u5r	Alarm on/off		5tbY	5tbY	5tbY	5tbY	5tbY	5tbY	5tbY	
	u5r	Vector shift	°	10.0	10.0	10.0	10.0	10.0	10.0	10.0	
	doF	OFF-delay	s	3	3	3	3	3	3	3	
	dEon	Suppression time	s	2	2	2	3	3	3	3	
	u5r	Number of phases		3Ph	3Ph	3Ph	3Ph	3Ph	3Ph	3Ph	
rocF	rocF	Alarm on/off		oFF	oFF	oFF	oFF	oFF	oFF	oFF	
	dFdt	delta f / delta t	Hz /s	0.800	0.800	0.800	0.800	0.800	0.800	0.800	
	PEr	periods		4	4	4	4	4	4	4	
	dRL	Response time	s	0.10	0.10	0.10	0.10	0.10	0.10	0.10	
	doF	OFF-delay	s	60	60	60	60	60	60	60	
rEL	ErEL	Response time	s	5.0	5.0	5.0	oFF	oFF	oFF	oFF	
ddi	ddi	Display delay	s	0.5	0.5	0.5	0.5	0.5	0.5	0.5	
	di t	Display duration 5Cn	s	3.5	3.5	3.5	3.5	3.5	3.5	3.5	
Si	U	Voltage	V	230	400	230	100	100	230	400	
	F	Frequency	Hz	50.00	50.00	50.00	50.00	50.00	50.00	50.00	
	u5r	Vector shift	°	0.0	0.0	0.0	0.0	0.0	0.0	0.0	
Code	Pin	Pincode		504	504	504	504	504	504	504	
Info	Fnr	Firmware version		0-05	0-05	0-05	0-05	0-05	0-05	0-05	
	Snr	Serial number		xxxx	xxxx	xxxx	xxxx	xxxx	xxxx	xxxx	
	h	Operating hours	h	xxxx	xxxx	xxxx	xxxx	xxxx	xxxx	xxxx	
	Err	Error counter		xxx	xxx	xxx	xxx	xxx	xxx	xxx	
	Pr	Program		1	2	7	3	4	5	6	

* factory preset

Display of the program:

Info → Pr

or when switching on

Einstellwerte (ab Werk) VDE-AR-N 4105:

Voltage decrease protection U< U_ 0,8 Un 184 V
 Frequency increase protection f> F^ 51,5 Hz Voltage increase protection U> U# 1,1 Un 253 V
 Frequency decrease protection f< F_ 47,5 Hz Voltage increase protection U>> U^ 1,15 Un 264 V
 For all Limits: ON-delay dRL = 100 ms, OFF-delay doF = 60 s

10 Troubleshooting

Error	Cause	Remedy
EEEE or -EEE appears in the display	Measured voltage, frequency or the vector shift is too large or too small	Consider the measuring range
Err4 appears in the display	Tolerance error, internal measurement value deviation of both channels	Perform a reset → interrupt the control supply voltage for >5 s *
Err5 appears in the display	Error internal regulation	
Err6 appears in the display	Communication error internal interface	
Err7 appears in the display even after 2 automatic repeated trials of switching on + LED K1 and/or K2 is lightning	Error feedback contacts, switches not connected correctly or broken or switches are controlled from other device	<u>Feedback contacts not connected</u> - set rEL. → ErEL. → oFF <u>Feedback contacts connected</u> - check the correct connection - Adjust the turn-on time of the section switch under rEL. → ErEL. - Perform a reset → interrupt the control supply voltage for >5 s
Err8 appears in the display	Hysteresis error: overlapping of the release points	Upper threshold value must be higher than the lower threshold value, check the threshold values
Err9 appears in the display	Configuration error	Reset to factory settings, see "Program setup" *
A time expires in the display	If a OFF-delay doF is active, the time runs down in the display (the shortest one first)	Wait until the time is complete (depending on the setting, several times may elapse one after the other)
Device cannot be configured / only the threshold values can be configured	Code lock / Sealing activated	When having problems with the code lock (Pin forgotten), the lock can be deactivated and the pin can be reset to 504, by pressing the button  until CoDE / oFF is shown in the display, while switching on the control supply voltage
Implausible voltage values	Pr selected with N, but N not connected	Select Pr without N or connect N
Loc appears in the display	Sealing is active	See „Program setup“
CoDE appears in the display	Code lock is active	See „Code lock“
StBY appears in the display	Standbymode, E1-E2 closed	check parameter u5r.
RL and LED Q3 (f>) is on, reading in good range	hysteresis for F~ incorrectly	Check hysteresis for reset point 50,05 Hz

* If the error cannot be patched by a reset, send back to factory for repair.